

CATÁLOGO PRODUCTOS
K.HARTWALL



LEAN MANUFACTURING

La manufactura esbelta significa asegurarse que las cantidades correctas de componentes lleguen al lugar correcto en el momento correcto. Es una cuestión de logística.

K.HARTWALL
Logistics Efficiency through Innovation

LEAN DOLLY

Diseñado para transportar SLC y bandejas de plástico estándar utilizadas en el. En la industria automovilística, las plataformas rodantes se pueden remolcar, apilar y transportar fácilmente.



**LEAN DOLLY
600X800 MM**



**LEAN DOLLY
600X 800MM**



800X600 MM



COMPOUND (CPD)WHEEL



POLYURETHANE WHEEL



RUBBER WHEEL



ESD HARD PLASTIC WHEEL & NON-PLASTIC MARKINGEDS HARD PLASTIC WHEEL



800X600 MM

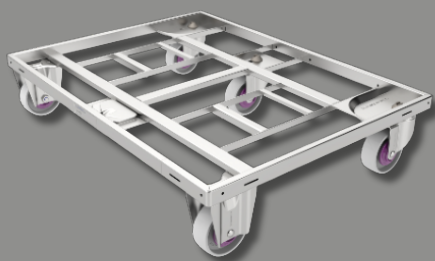

HDLL10109

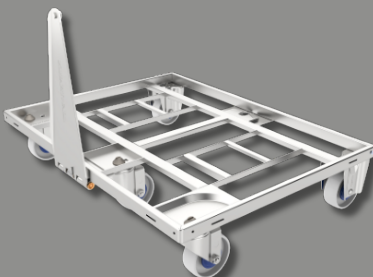

HDLL10077



800X600 MM

CATÁLOGO PRODUCTOS K.HARTWALL



LEAN DOLLY 1200X1800

LEAN DOLLY 1200X1800 MM

Diseñado para transportar paletas, jaulas, cajas y SLC ampliamente utilizados en la industria automotriz.

compatible tanto con su sistema de producción de leche como con su sistema automatizado.

LEAN DOLLY 1200X1800

Para optimizar el transporte externo y el almacenamiento, se puede utilizar el carro Lean junto con el palet adaptador Lean.



LEAN DOLLY 1200X1800



ADAPTOR PALLET



ADAPTOR PALLET



ADAPTOR PALLET



COMPOUND (CPD)WHEEL



POLYURETHANE WHEEL

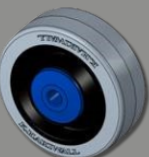

RUBBER WHEEL



ESD HARD PLASTIC WHEEL & NON-PLASTIC MARKINGES HARD PLASTIC WHEEL

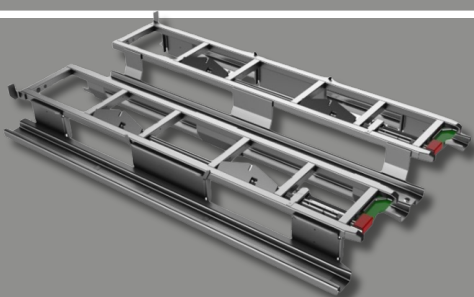

LEAN ADAPTOR PALLET



LEAN DOLLY 1200X1800 MM



LEAN DOLLY TIPO I - II - III

Diseñado para transportar paletas, jaulas, cajas y SLC ampliamente utilizados en la industria automotriz. compatible tanto con su tren de remolque como con sus sistemas automatizados

LEAN DOLLY TIPO I-II-III

Para optimizar el transporte externo y el almacenamiento, se puede utilizar el carro Lean junto con el lean adaptor pallet.

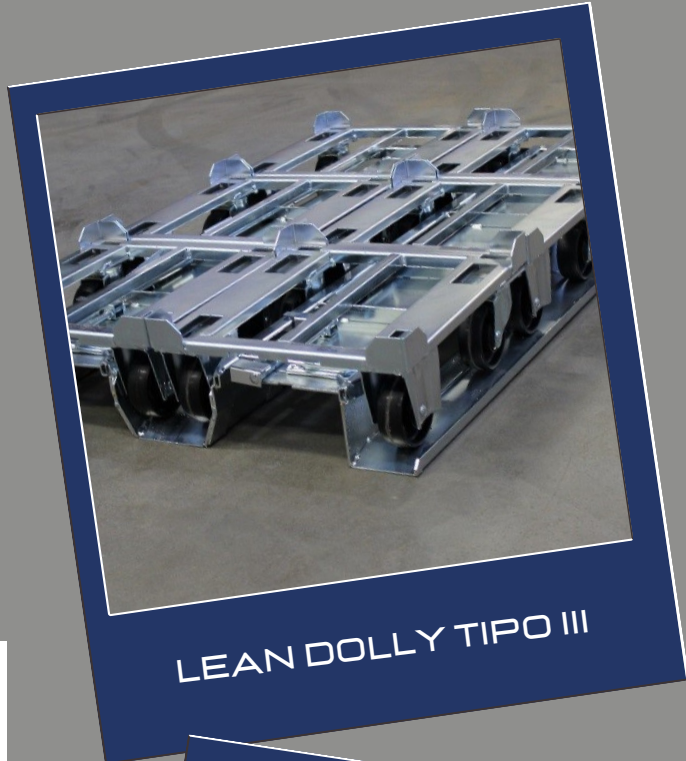
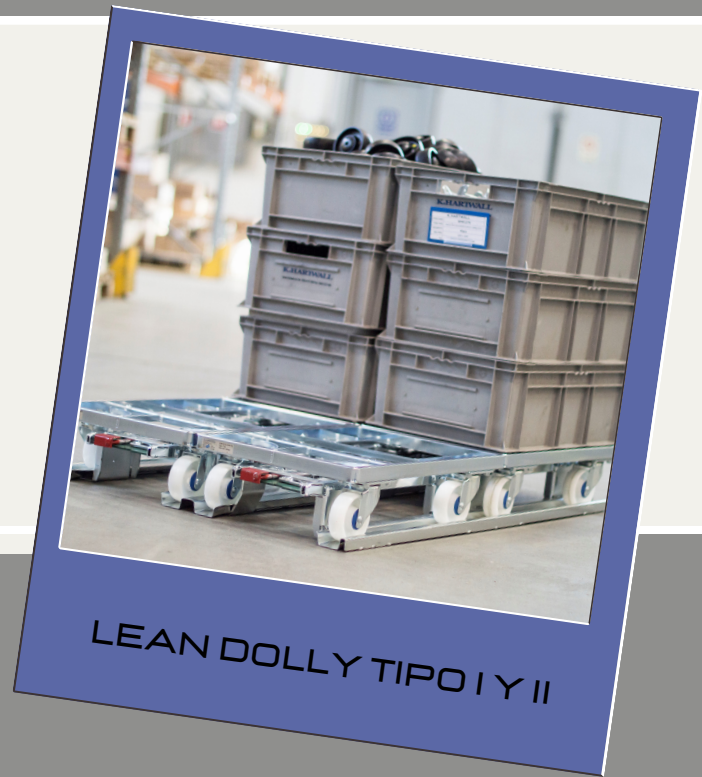

	COMPOUND (CPD)WHEEL
	POLYURETHANE WHEEL
	RUBBER WHEEL
	ESD HARD PLASTIC WHEEL & NON-PLASTIC MARKING ESD HARD PLASTIC WHEEL

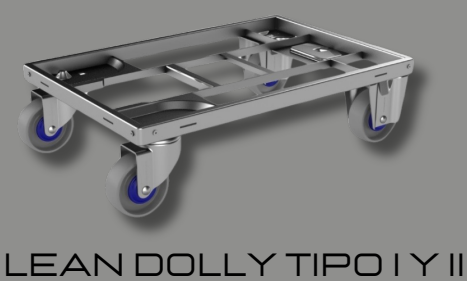

LEAN DOLLY TIPO I Y II



LEAN DOLLY TIPO III

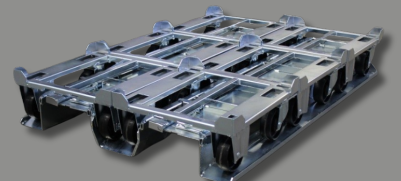



LEAN DOLLY TIPO IV-V

Diseñado para transportar paletas, jaulas, cajas y SLC ampliamente utilizados en la industria automotriz. compatible tanto con su tren de remolque como con sus sistemas automatizados

LEAN DOLLY TIPO IV - V

Para optimizar el transporte externo y el almacenamiento, se puede utilizar el carro Lean junto con el lean adaptor pallet.

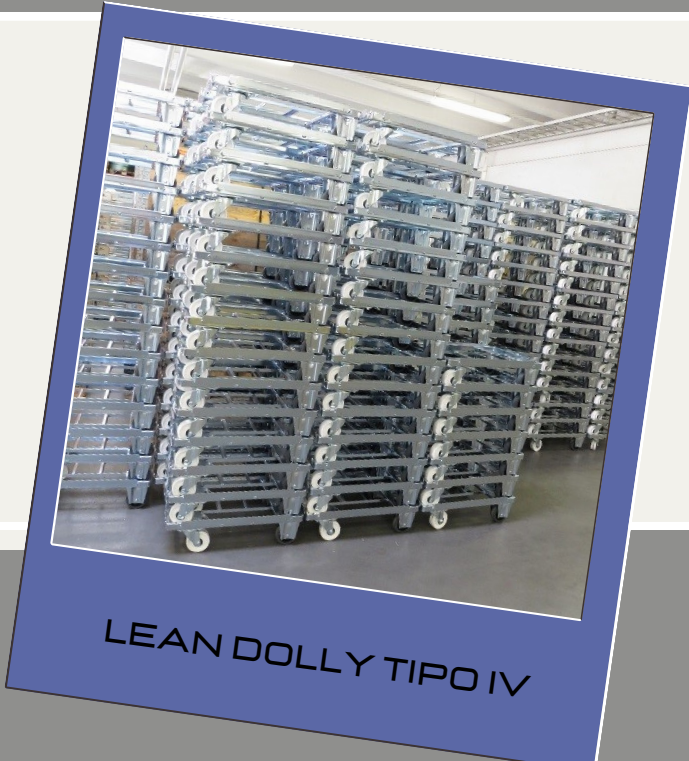

-  COMPOUND (CPD) WHEEL
-  POLYURETHANE WHEEL
-  RUBBER WHEEL
-  ESD HARD PLASTIC WHEEL & NON-PLASTIC MARKINGS HARD PLASTIC WHEEL



ACCESORIO ERGONÓMICO COMPATIBLE CON TODOS LOS TIPOS DE DOLLY

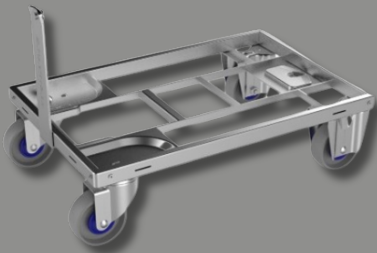

LEAN DOLLY TIPO VII



LEAN DOLLY TIPO VII



LEAN PALLET SIZE DOLLY

El Lean Pallet Size Dolly está diseñado para transportar palés, jaulas, cajas y SLC ampliamente utilizados en la industria automotriz.

LEAN PALLET SIZE DOLLY

Está diseñado para ser compatible tanto con su tren remolcador como con sus sistemas automatizados.

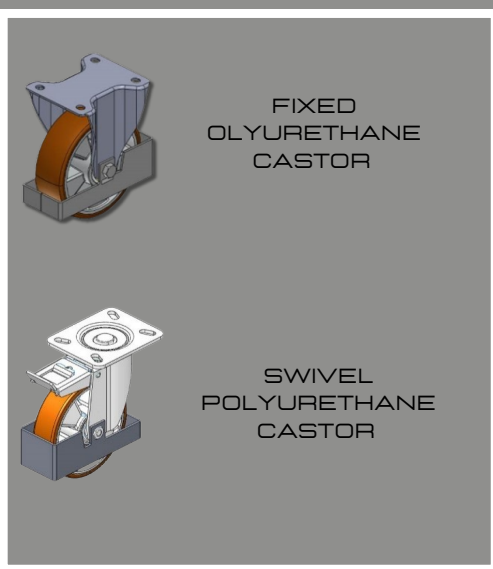
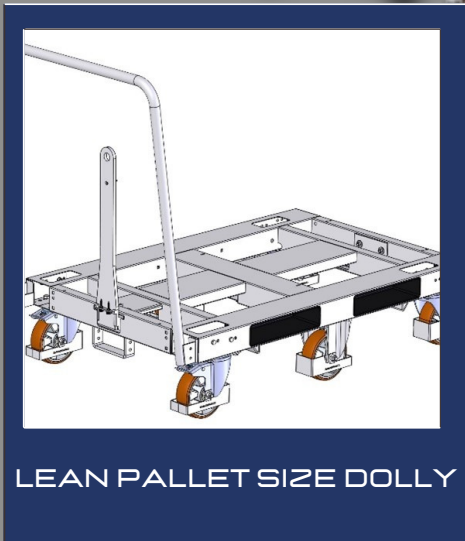
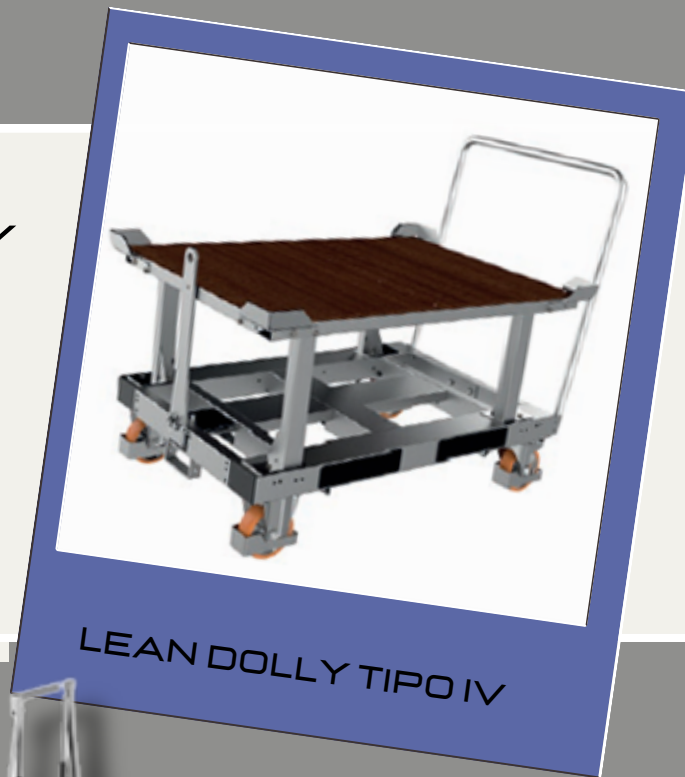

CONFIGURACIÓN DE PLATAFORMA RODANTE LEAN PALLET SIZE CON 2 RUEDAS FIJAS Y 2 GIRATORIAS Y SISTEMA DE BARRA DE TIRO INVERTIDA:

1200 x 800					
Number of Lean Pallet Size Dollies					
1	2	3	4	5	6
Dimension A, meters**					
1.5	1.6	1.7	1.9	2.0	2.2
1200 x 1000					
Number of Lean Pallet Size Dollies					
1	2	3	4	5	6
Dimension A, meters**					
1.6	1.7	1.8	2.0	2.2	2.4

1200 x 800					
Number of Lean Pallet Size Dollies					
1	2	3	4*	5*	6*
Dimension A, meters**					
1.4	1.5	1.6	1.7	1.8	2.0
1200 x 1000					
Number of Lean Pallet Size Dollies					
1	2	3	4*	5*	6*
Dimension A, meters**					
1.5	1.6	1.7	1.8	1.9	2.2

CATÁLOGO PRODUCTOS K.HARTWALL



SHELF WAGON

LEAN SHELF WAGON

El Lean Shelf Wagon ha sido diseñado para transportar SLC y bandejas de componentes ampliamente utilizados en la industria automotriz.

LEAN SHELF WAGON

Optimiza el transporte externo y el almacenamiento, se puede utilizar el carro Lean junto con el Lean adaptor pallet



SHELF WAGON

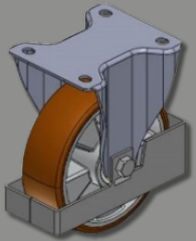

FIXED
POLYURETHANE
CASTOR

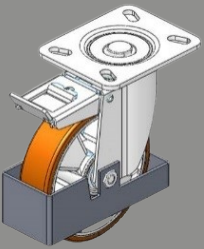

SWIVEL
POLYURETHANE
CASTOR



LEAN PALLET SIZE DOLLY

External dimensions	806 x 1260 x 1680 mm
Tare weight (with 2 or 3 shelves+ base)	113-126 kg
Wheel size	160 mm wheels
Wheel type	2 fixed & 2 swivel
Wheel material	PU and CPD
Working load capacity	
Shelf	150 kg
Shelf if above 1,2m	100 kg
Total unit	450 kg

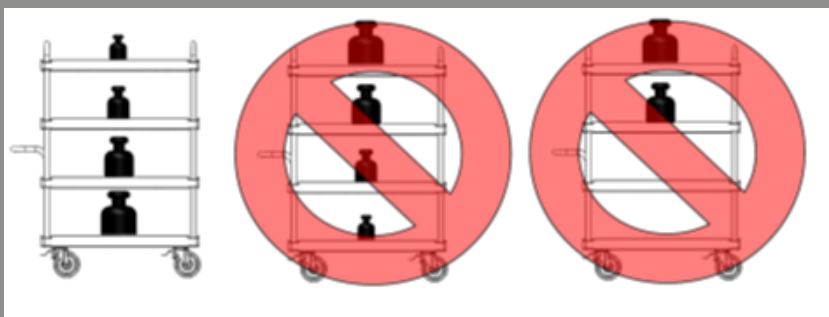

CATÁLOGO PRODUCTOS H.HARTWALL

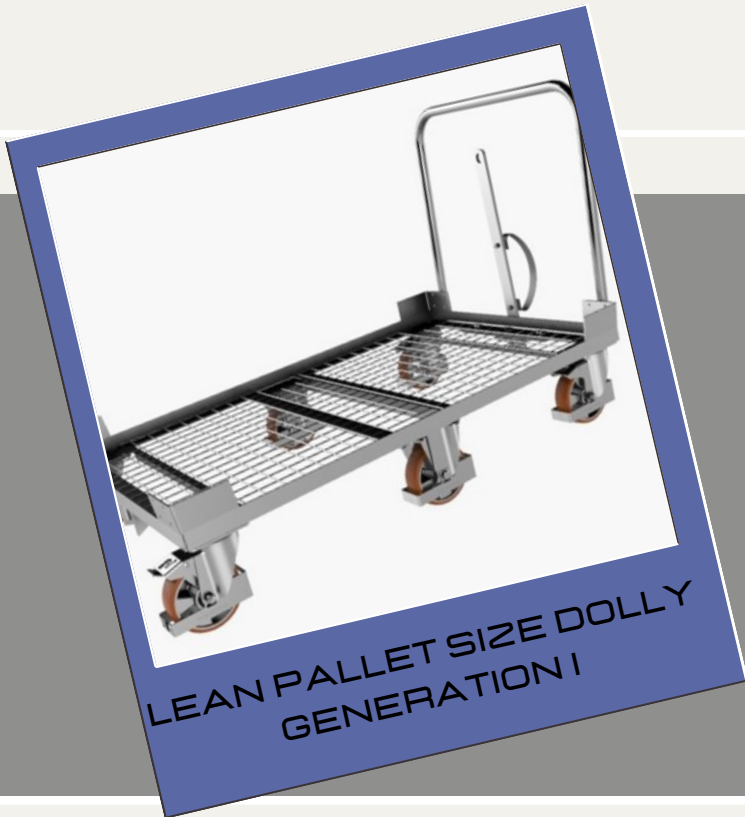

LEAN PALLET SIZE DOLLY- GENERATION I

El Lean Pallet Size Dolly ha sido diseñado para transportar palés, jaulas, cajas y SLC ampliamente utilizados en la industria automotriz. Está diseñado para ser compatible tanto con su tren de remolque como con sus sistemas automatizados.

Pallet Size Dolly es perfecta para quienes no necesitan una capacidad de carga superior a los 800 kg.



PU WHEEL



CPD WHEEL

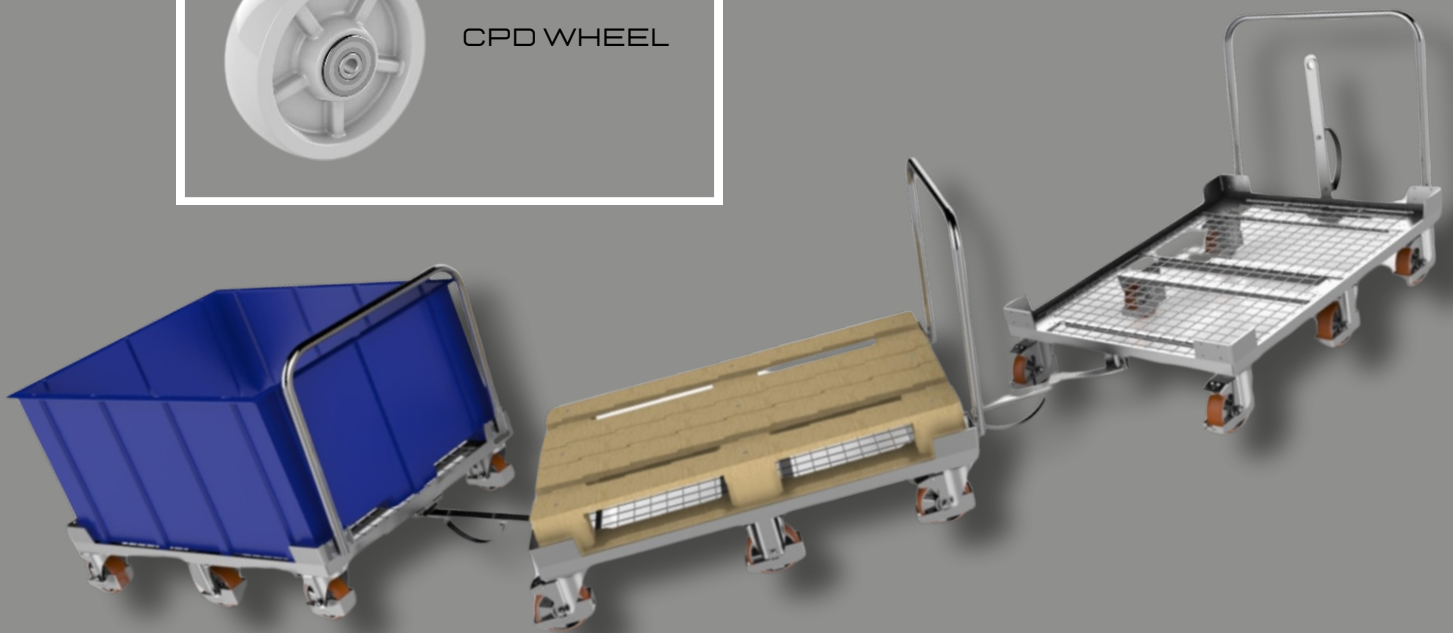

MINI LEAN PALLET SIZE DOLLY EUROSIZED

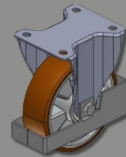

FIXED
POLYURETHANE
CASTOR

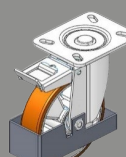

SWIVEL
POLYURETHANE
CASTOR

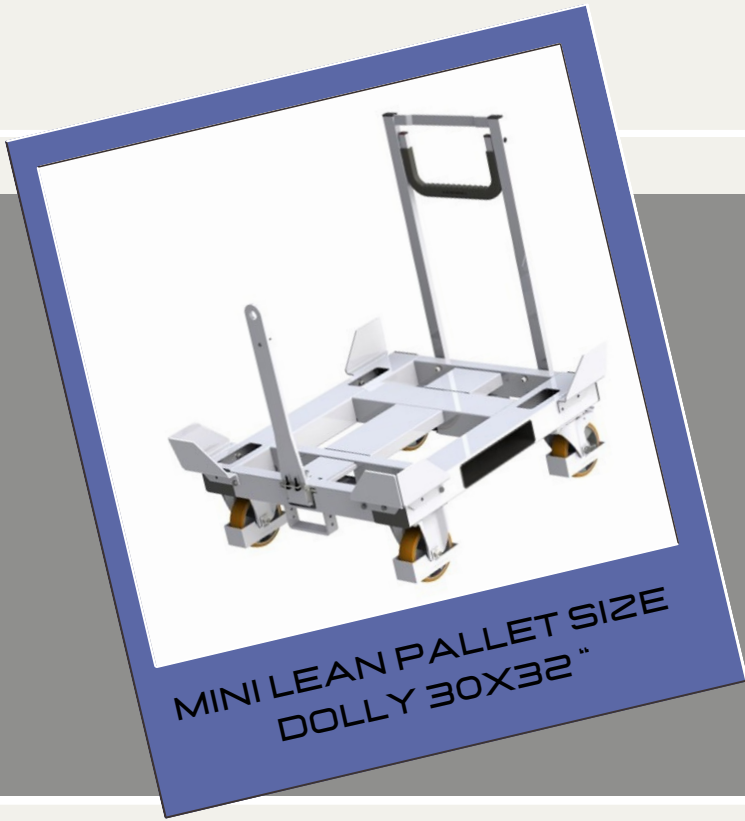

LEAN PALLET SIZE DOLLY- GENERATION I

El Lean Pallet Size Dolly ha sido diseñado para transportar palés, jaulas, cajas y SLC ampliamente utilizados en la industria automotriz. Está diseñado para ser compatible tanto con su tren de remolque como con sus sistemas automatizados.

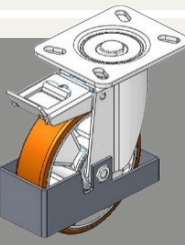
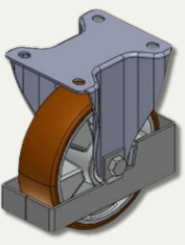

MINI LEAN SHELF WAGON

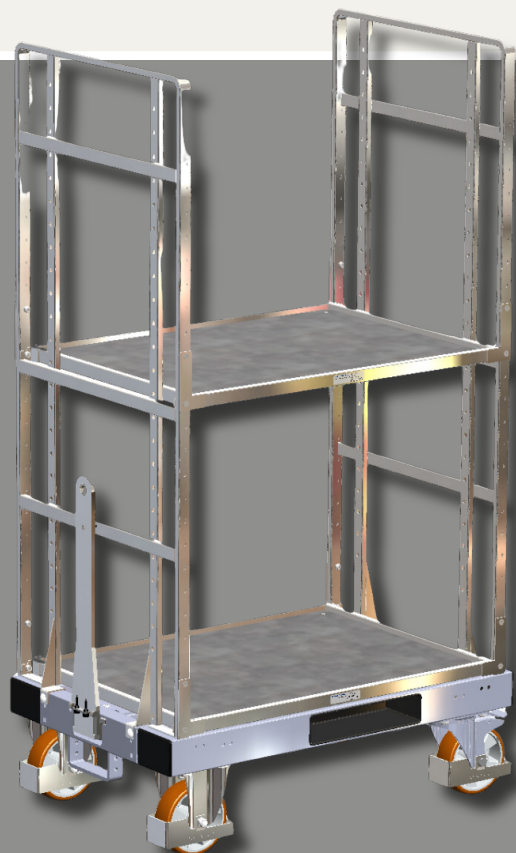
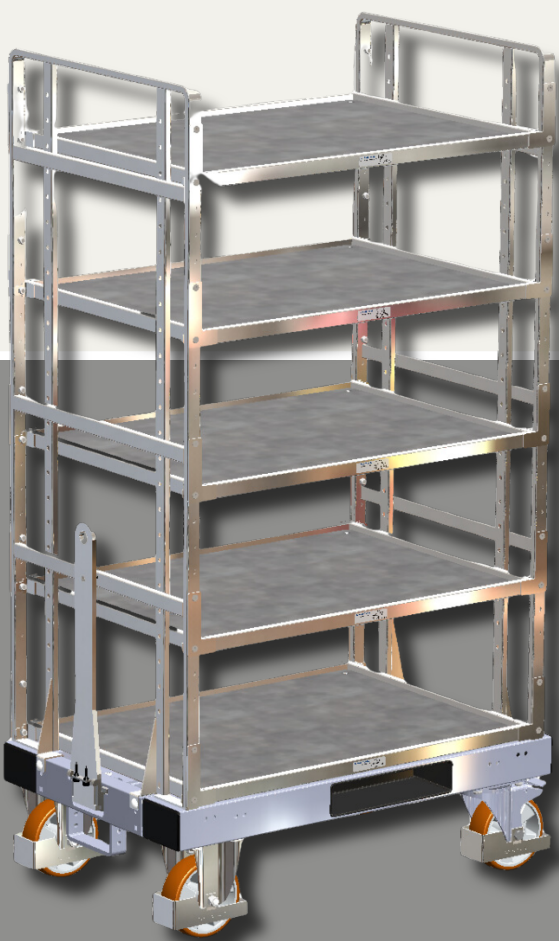



TREN REMOLCADOR
LIFTLINER

LIFTLINER

Tren remolcador LiftLiner[®]

LiftLiner[®] es una solución única de tren remolcador para logística interna y una excelente opción para entornos sin montacargas.



TREN REMOLCADOR LIFLINER

Carga y descarga por ambos lados
Con LiftLiner[®] evita las complejidades de secuenciar las entregas a la línea de producción por adelantado.



POR QUE LIFTLINER



MÁXIMA FLEXIBILIDAD Y EXCELENTE ERGONOMÍA

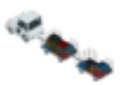

EL REMOLCADOR MÁS CORTO DEL MERCADO

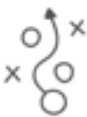

EXCELENTE SEGUIMIENTO Y MANIOBRABILIDAD ÁGIL



AGILIDAD, VELOCIDAD Y ALTA EFICIENCIA



UNIDAD MODULAR CON ESPACIO PARA PERSONALIZACIÓN



UNIDAD SEGURA Y AMIGABLE PARA EL OPERADOR

